

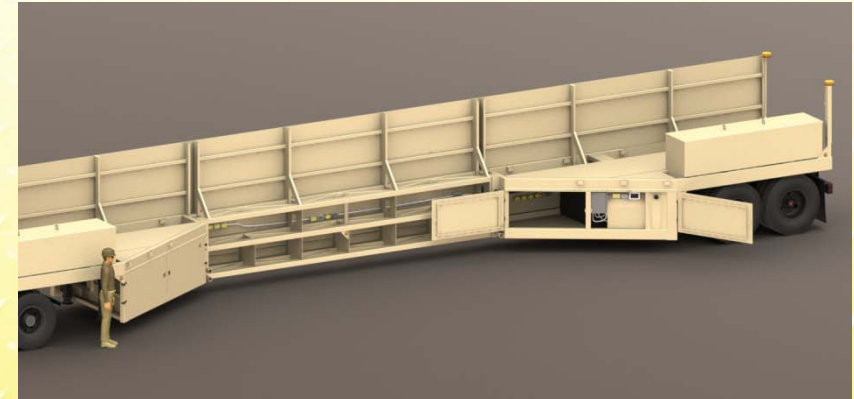

Highly Mobile Protection

Mobile Barriers MBT-1®

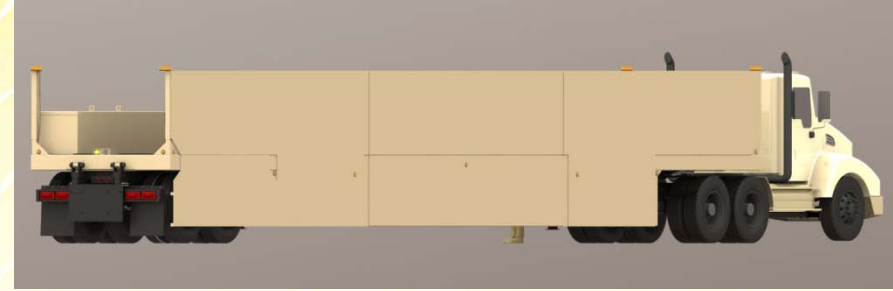



Modular & Customizable

Easy to maintain and repair – replace only what's damaged

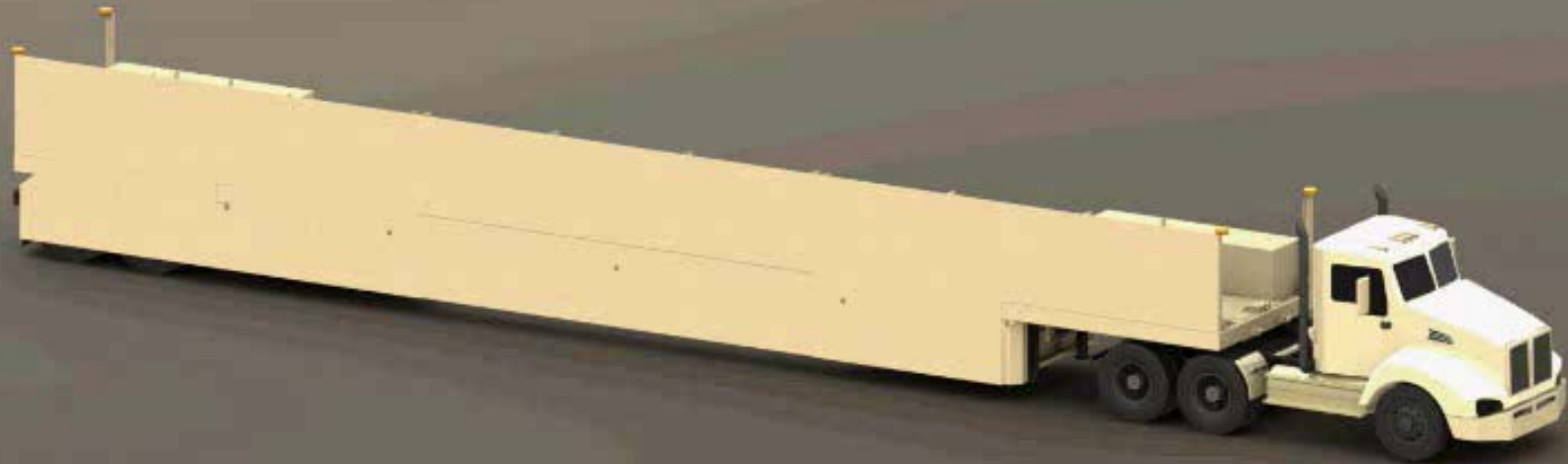

Rendering Created With SolidWorks
& Powered by





Crash Highlights





Drive at Speed

(Drive & Park)



+00:00:00:15





Configurable

Side

(Left or Right)

Detachable rear axle assembly rolls out to allow tractor to attach at either end.

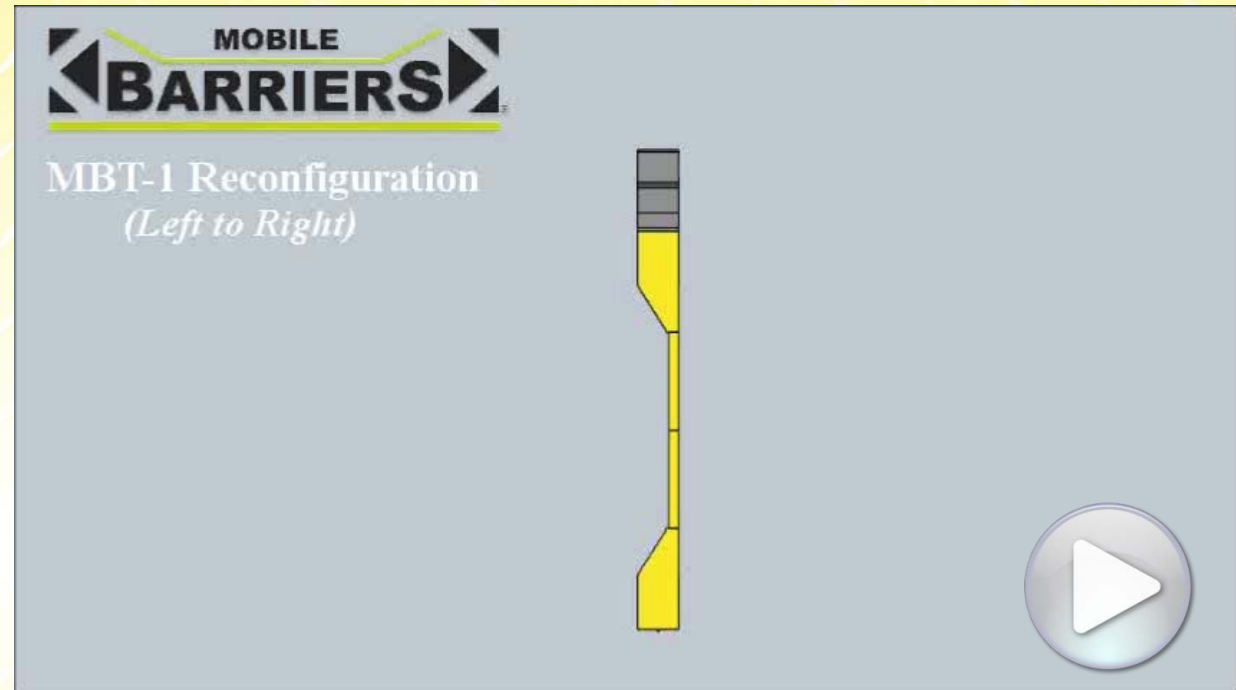

Length

(Add or Remove Wall Sections)

42-102'



Two 21' axle platforms = 42' of protection.



Two 21' Axle Platforms + One 10' Wall Section = 52' of Protective Length.



Two 21' Axle Platforms + One 20' Wall Section = 62' of Protective Length.



Two 21' Axle Platforms + One 20' Wall Section + One 10' Wall Section = 72' of Protective Length.



Two 21' Axle Platforms + Two 20' Wall Sections = 82' of Protective Length.



Two 21' Axle Platforms + Three 20' Wall Section = 102' of Protective Length.



Versatile & Strong



**Integrated
Power
Lights
Storage**

(lockable and on deck)



**Various Options
On Decks &
In Walls**

Turrets, Cranes,
Cameras,
Comm Towers
Speakers

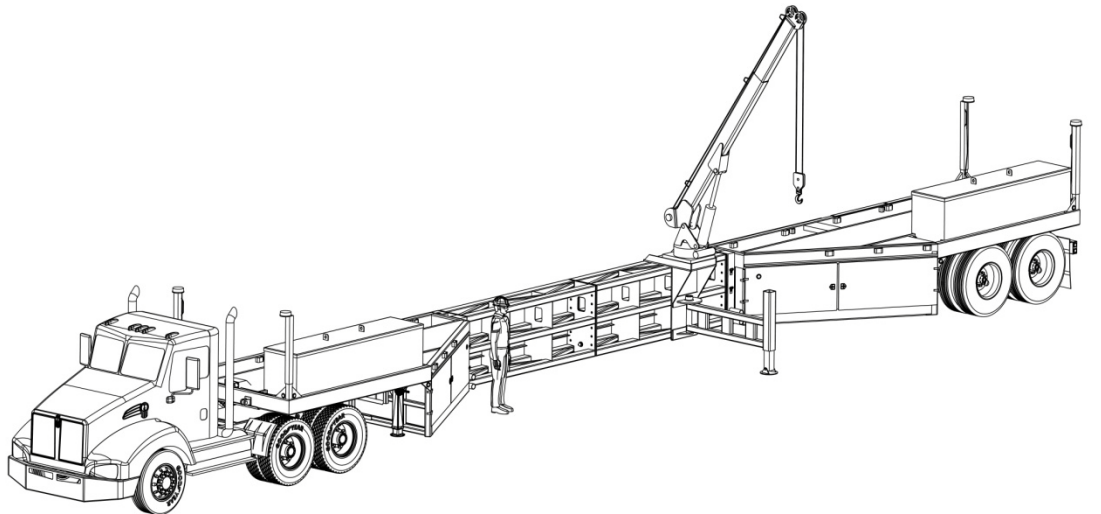



MBT-1... Highly Mobile Protection

For Boarder/Emergency Protection, Spot Inspections, Check Points, Protected Areas & Rolling Perimeters

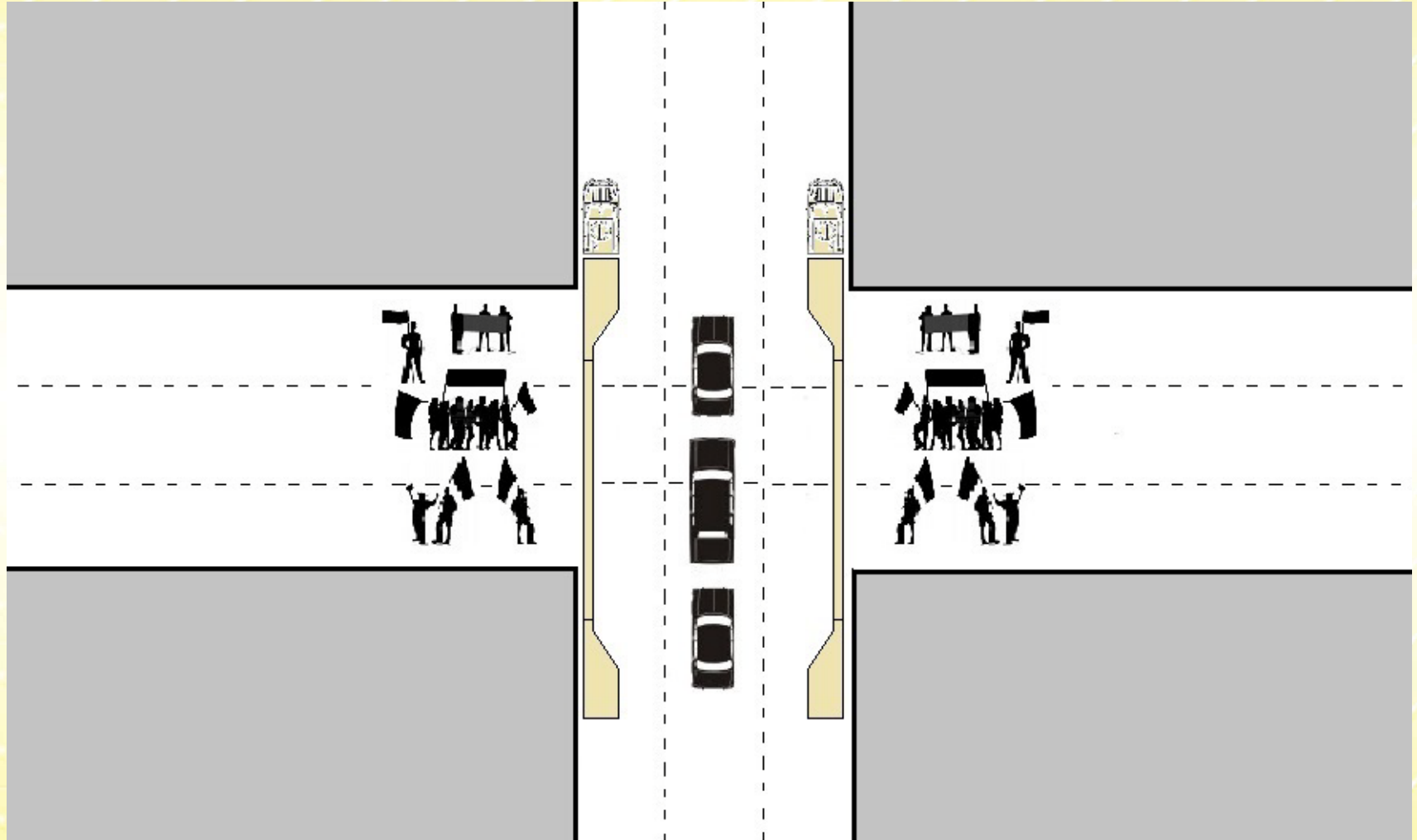



MBT-1... Highly Mobile Protection

For Boarder/Emergency Protection, Spot Inspections, Check Points, Protected Areas & Rolling Perimeters

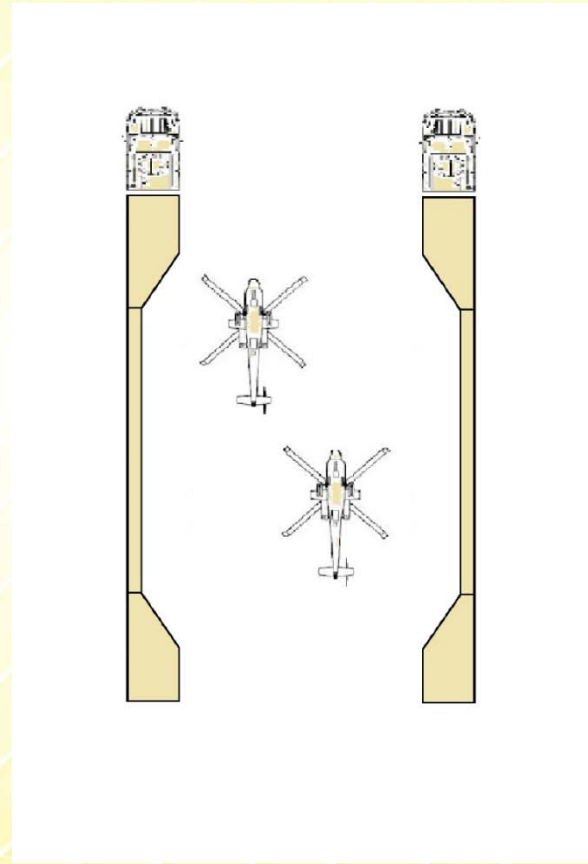
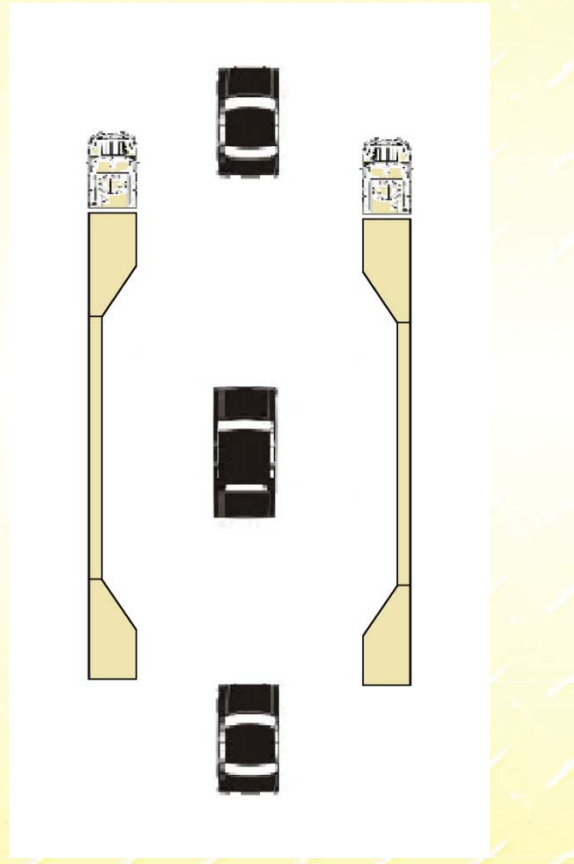
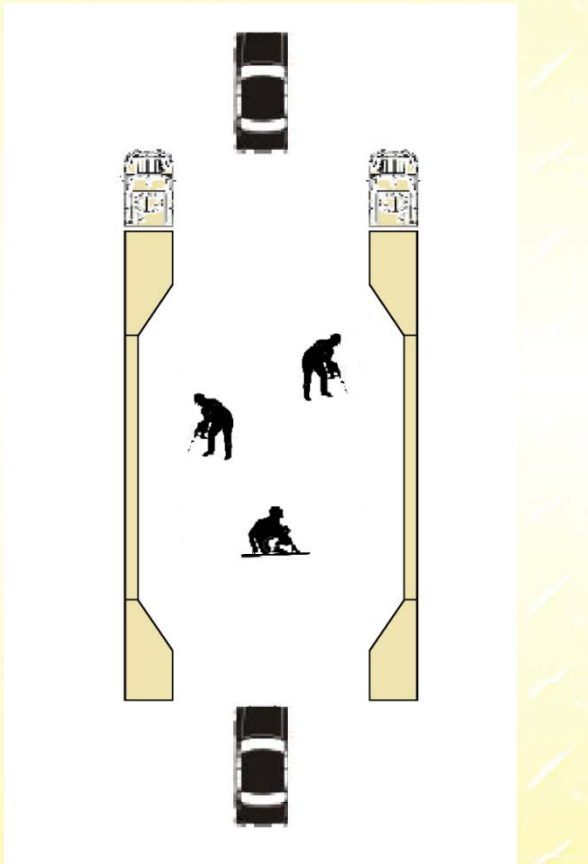



MBT-1... Highly Mobile Protection

For Boarder/Emergency Protection, Spot Inspections, Check Points, Protected Areas & Rolling Perimeters

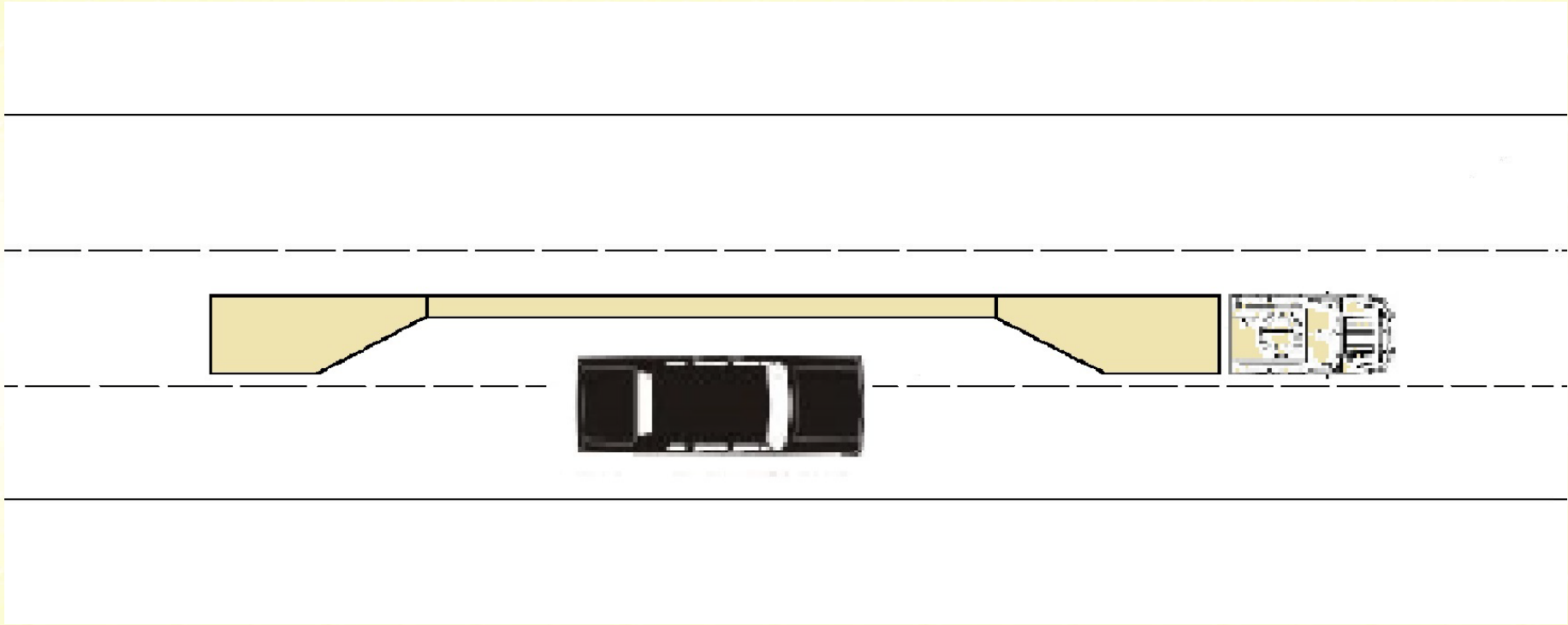



MBT-1... Highly Mobile Protection

For Boarder/Emergency Protection, Spot Inspections, Check Points, Protected Areas & Rolling Perimeters

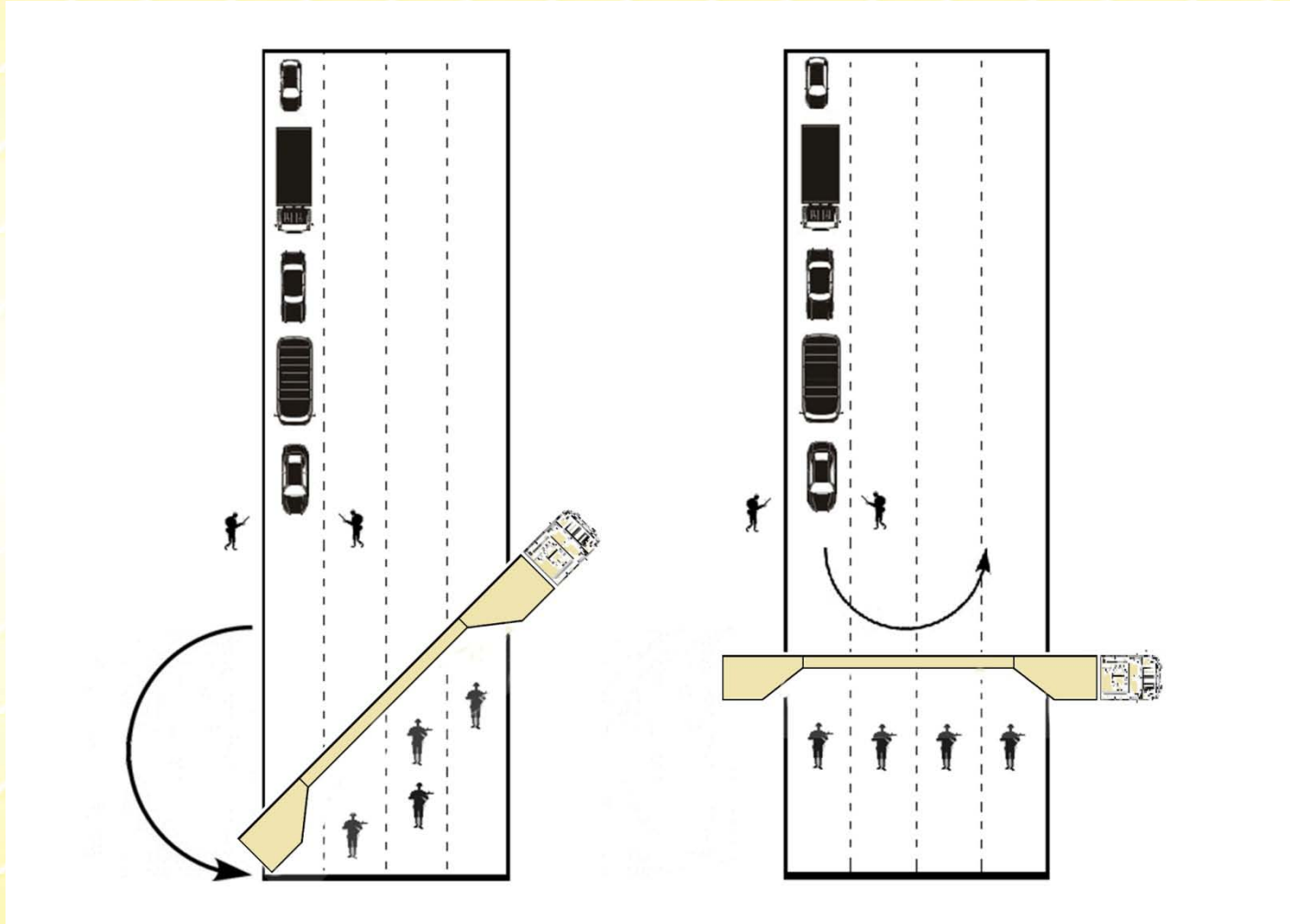



MBT-1... Highly Mobile Protection

For Boarder/Emergency Protection, Spot Inspections, Check Points, Protected Areas & Rolling Perimeters

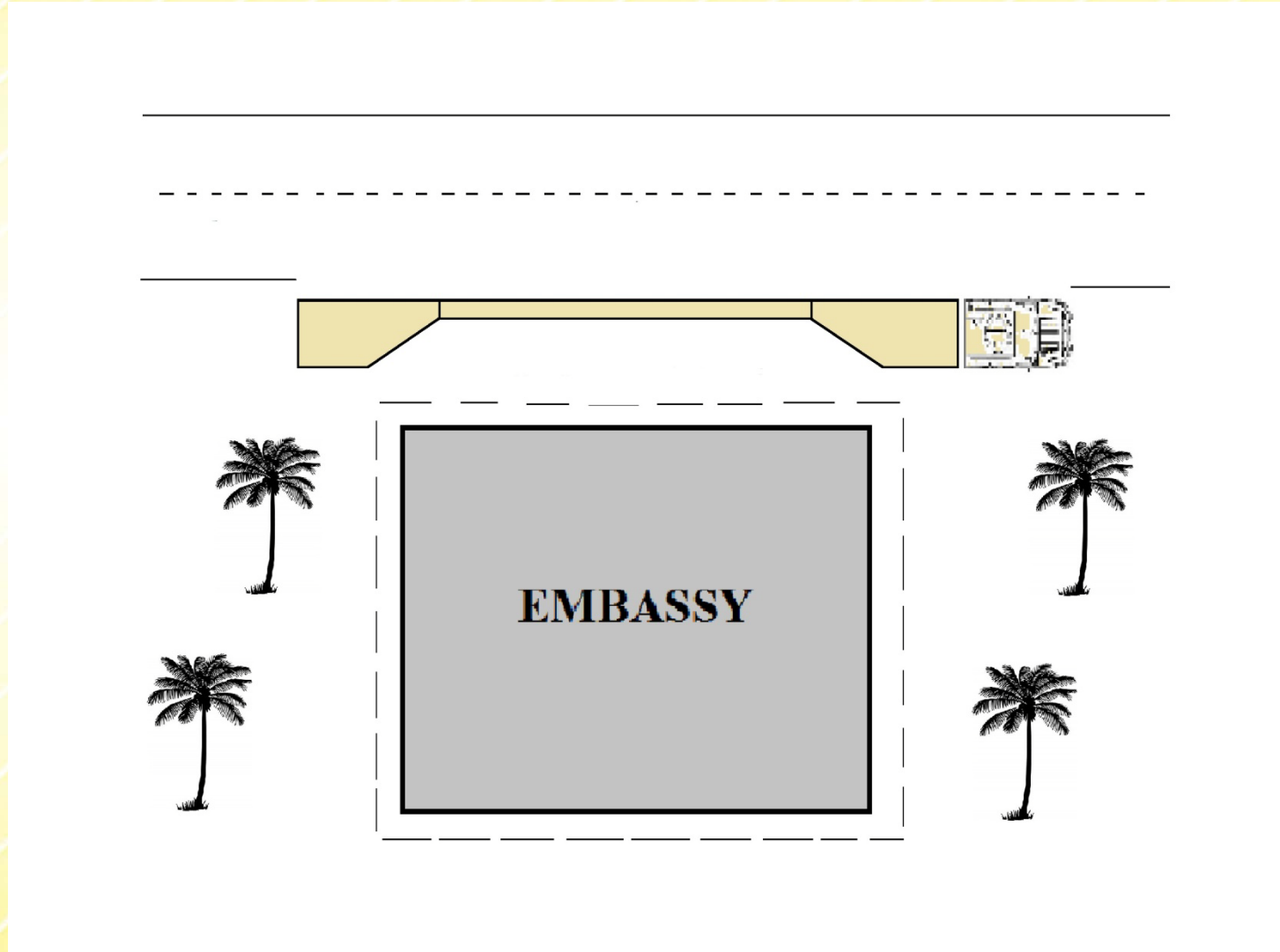



MBT-1... Highly Mobile Protection

For Boarder/Emergency Protection, Spot Inspections, Check Points, Protected Areas & Rolling Perimeters

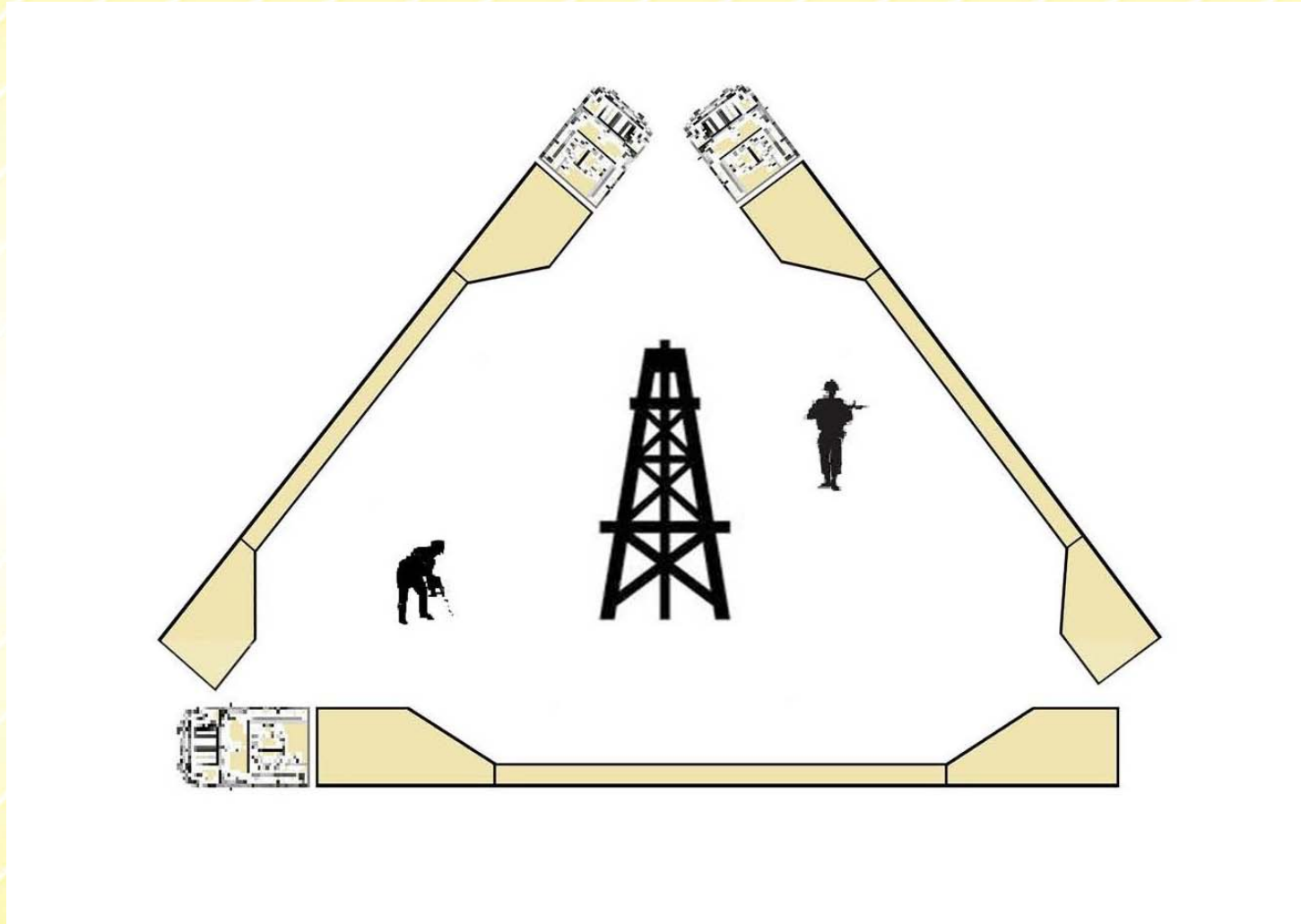



Mobile Barriers MBT-1®

“Highly Mobile Protection”



Mobile Barriers LLC | Denver Offices: 24918 Genesee Trail Road | Golden, Colorado USA 80401 | Phone 1.303.526.5995

www.mobilebarriers.com

international web site: int.mobilebarriers.com

MOBILE BARRIERS MBT-1® is protected under Pat. Nos. 7572022, 7901117, 8322945, 8465047, 8628110, 8657525, 8740241, 8777255, 8845229, 9267250, 9273437, 9481969, AU010217820, AU2010217820, AU2014265099, CAN2753751, EP2401436, EP2310574, EP2816157, EP2818595, MX322007, NZ590357, NZ594760, NZ611184 & other patents pending.

MOBILE BARRIERS & Design, Lines and MBT-1 are Registered Trademarks. © 2007-2017 Mobile Barriers LLC. All rights reserved.

CAGE Code: 70N96